

Smart Highside Power Switch TEMPFET®

BTS 100

Features

- P channel
- Enhancement mode
- Temperature sensor with thyristor characteristic
- The drain pin is electrically shorted to the tab

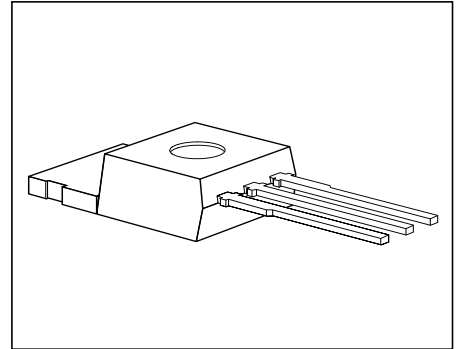

Pin	1	2	3
	G	D	S

Type	V_{DS}	I_D	$R_{DS(on)}$	Package	Ordering Code
BTS 100	- 50 V	- 8 A	0.3 Ω	TO-220AB	C67078-A5007-A2

Maximum Ratings

Parameter	Symbol	Values	Unit
Drain-source voltage	V_{DS}	- 50	V
Drain-gate voltage, $R_{GS} = 20 \text{ k}\Omega$	V_{DGR}	- 50	
Gate-source voltage	V_{GS}	± 20	
Continuous drain current, $T_C = 30 \text{ }^\circ\text{C}$	I_D	- 8.0	A
ISO drain current $T_C = 85 \text{ }^\circ\text{C}$, $V_{GS} = 10 \text{ V}$, $V_{DS} = 0.5 \text{ V}$	I_{D-ISO}	- 1.5	
Pulsed drain current, $T_C = 25 \text{ }^\circ\text{C}$	$I_{D \text{ puls}}$	- 32	
Short circuit current, $T_j = - 55 \dots + 150 \text{ }^\circ\text{C}$	I_{SC}	- 25	
Short circuit dissipation, $T_j = - 55 \dots + 150 \text{ }^\circ\text{C}$	P_{SCmax}	500	W
Power dissipation	P_{tot}	40	
Operating and storage temperature range	T_j, T_{stg}	- 55 ... + 150	$^\circ\text{C}$
DIN humidity category, DIN 40 040	-	E	-
IEC climatic category, DIN IEC 68-1	-	55/150/56	
Thermal resistance			K/W
Chip-case	$R_{th \text{ JC}}$	≤ 3.1	
Chip-ambient	$R_{th \text{ JA}}$	≤ 75	

Electrical Characteristics

at $T_j = 25\text{ °C}$, unless otherwise specified.

Parameter	Symbol	Values			Unit
		min.	typ.	max.	

Static Characteristics

Drain-source breakdown voltage $V_{GS} = 0, I_D = -0.25\text{ mA}$	$V_{(BR)DSS}$	-50	-	-	V
Gate threshold voltage $V_{GS} = V_{DS}, I_D = -1\text{ mA}$	$V_{GS(th)}$	-2.5	-3.0	-3.5	
Zero gate voltage drain current $V_{GS} = 0\text{ V}, V_{DS} = -50\text{ V}$ $T_j = 25\text{ °C}$ $T_j = 150\text{ °C}$	I_{DSS}	-	-1 -100	-10 -300	μA
Gate-source leakage current $V_{GS} = -20\text{ V}, V_{DS} = 0$ $T_j = 25\text{ °C}$ $T_j = 150\text{ °C}$	I_{GSS}	-	-10 -2	-100 -4	nA μA
Drain-source on-state resistance $V_{GS} = -10\text{ V}, I_D = -5\text{ A}$	$R_{DS(on)}$	-	0.25	0.3	Ω

Dynamic Characteristics

Forward transconductance $V_{DS} \geq 2 \times I_D \times R_{DS(on)max}, I_D = -5\text{ A}$	g_{fs}	1.5	2.3	4.0	S
Input capacitance $V_{GS} = 0, V_{DS} = -25\text{ V}, f = 1\text{ MHz}$	C_{iss}	-	900	1200	μF
Output capacitance $V_{GS} = 0, V_{DS} = -25\text{ V}, f = 1\text{ MHz}$	C_{oss}	-	350	550	
Reverse transfer capacitance $V_{GS} = 0, V_{DS} = -25\text{ V}, f = 1\text{ MHz}$	C_{rss}	-	130	230	
Turn-on time t_{on} , ($t_{on} = t_{d(on)} + t_r$) $V_{CC} = -30\text{ V}, V_{GS} = -10\text{ V}, I_D = -2.9\text{ A},$ $R_{GS} = 50\text{ }\Omega$	$t_{d(on)}$	-	20	30	ns
	t_r	-	60	95	
Turn-off time t_{off} , ($t_{off} = t_{d(off)} + t_f$) $V_{CC} = -30\text{ V}, V_{GS} = -10\text{ V}, I_D = -2.9\text{ A},$ $R_{GS} = 50\text{ }\Omega$	$t_{d(off)}$	-	70	90	
	t_f	-	55	75	

Electrical Characteristics (cont'd)at $T_j = 25\text{ °C}$, unless otherwise specified.

Parameter	Symbol	Values			Unit
		min.	typ.	max.	

Reverse Diode

Continuous source current	I_S	–	–	– 8.0	A
Pulsed source current	I_{SM}	–	–	– 32	
Diode forward on-voltage $I_F = -16\text{ A}$, $V_{GS} = 0$	V_{SD}	–	– 1.0	– 1.7	V
Reverse recovery time $I_F = I_S$, $di_F/dt = -100\text{ A}/\mu\text{s}$, $V_R = -30\text{ V}$	t_{rr}	–	90	–	ns
Reverse recovery charge $I_F = I_S$, $di_F/dt = -100\text{ A}/\mu\text{s}$, $V_R = -30\text{ V}$	Q_{rr}	–	0.23	–	μC

Temperature Sensor

Forward voltage $I_{TS(on)} = -10\text{ mA}$, $T_j = -55 \dots +150\text{ °C}$ Sensor override, $t_p \leq 100\text{ }\mu\text{s}$ $T_j = -55 \dots +160\text{ °C}$	$V_{TS(on)}$	–	– 1.4	– 1.5	V
		–	–	– 10	
Forward current $T_j = -55 \dots +150\text{ °C}$ Sensor override, $t_p \leq 100\text{ }\mu\text{s}$ $T_j = -55 \dots +160\text{ °C}$	$I_{TS(on)}$	–	–	– 10	mA
		–	–	– 600	
Holding current, $V_{TS(off)} = -5\text{ V}$, $T_j = 25\text{ °C}$ $T_j = 150\text{ °C}$	I_H	– 0.05 – 0.05	– 0.1 – 0.2	– 0.5 – 0.3	
Switching temperature $V_{TS} = -5\text{ V}$	$T_{TS(on)}$	150	–	–	°C
Turn-off time $V_{TS} = -5\text{ V}$, $I_{TS(on)} = -2\text{ mA}$	t_{off}	0.5	–	2.5	μs

Examples for short-circuit protection

at $T_j = -55 \dots +150 \text{ }^\circ\text{C}$, unless otherwise specified.

Parameter	Symbol	Example			Unit
		1	2	–	
Drain-source voltage	V_{DS}	– 15	– 30	–	V
Gate-source voltage	V_{GS}	– 10	– 8.2	–	
Short-circuit current	I_{SC}	≤ -25	≤ -16	–	A
Short-circuit dissipation	P_{SC}	375	480	–	W
Response time $T_j = 25 \text{ }^\circ\text{C}$, before short circuit	$t_{SC(off)}$	55	55	–	ms

Short-circuit protection $I_{SC} = f(V_{DS})$

Parameter: V_{GS}

Diagram to determine I_{SC} for $T_j = -55 \dots +150 \text{ }^\circ\text{C}$

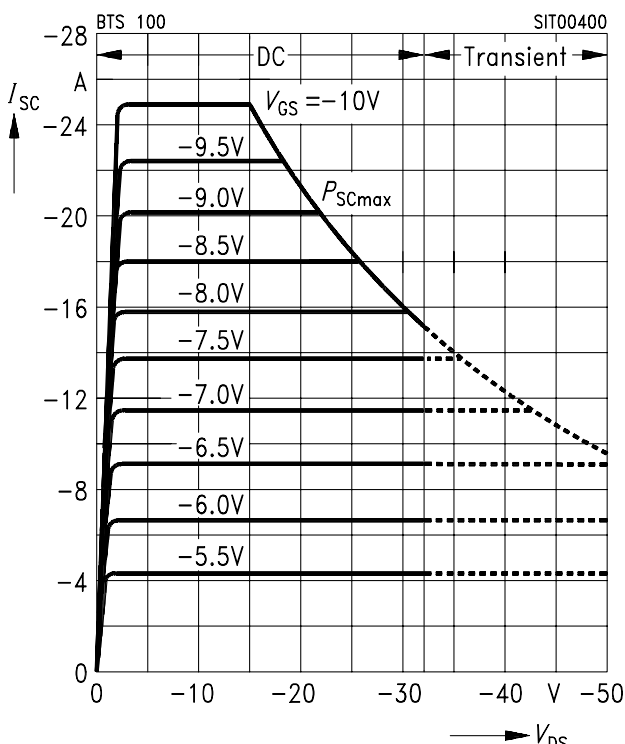

Max. gate voltage $V_{GS(SC)} = f(V_{DS})$

Parameter: $T_j = -55 \dots +150 \text{ }^\circ\text{C}$

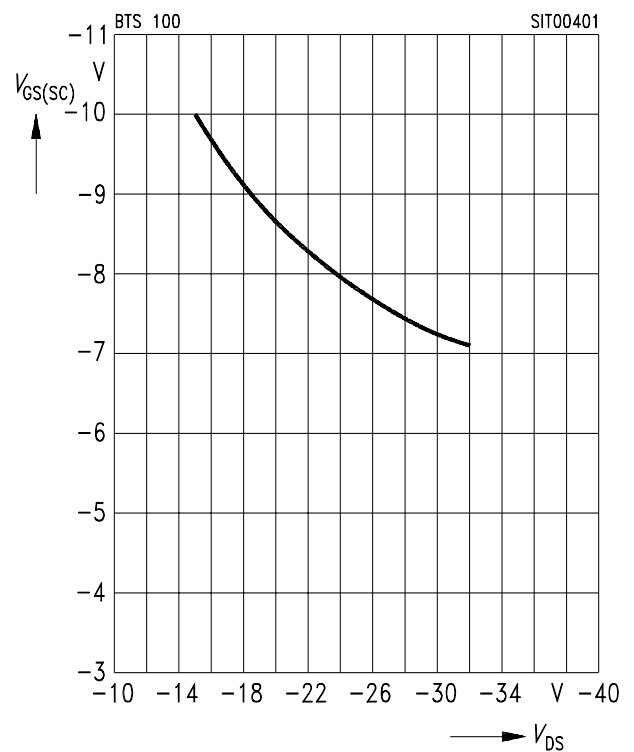

Max. power dissipation $P_{tot} = f(T_C)$

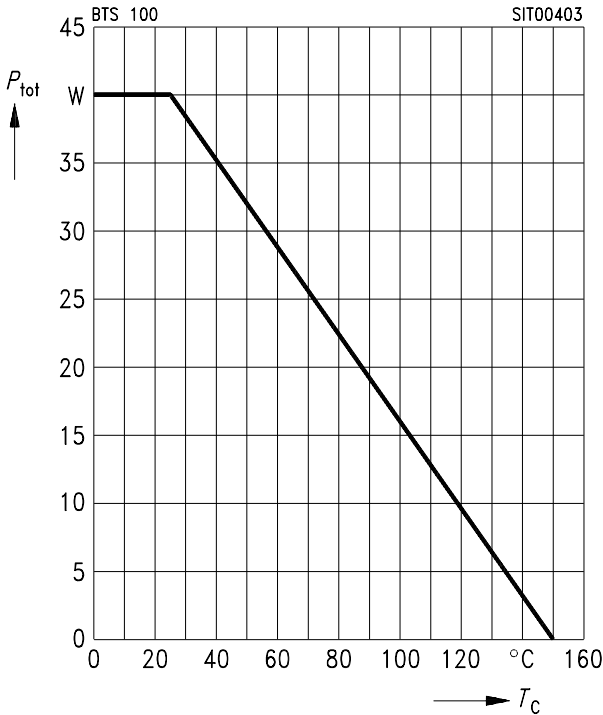

Typ. drain-source on-state resistance $R_{DS(on)} = f(I_D)$

Parameter: V_{GS}

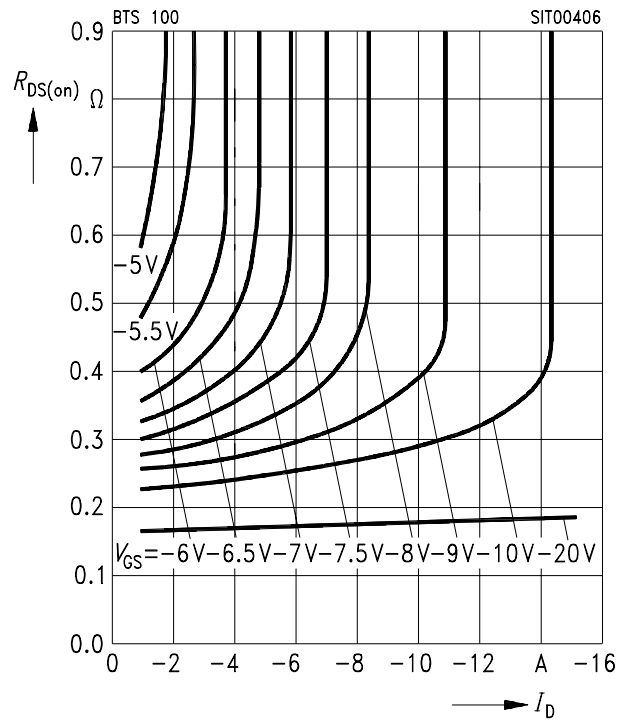

Typical output characteristics $I_D = f(V_{DS})$

Parameter: $t_p = 80 \mu s$

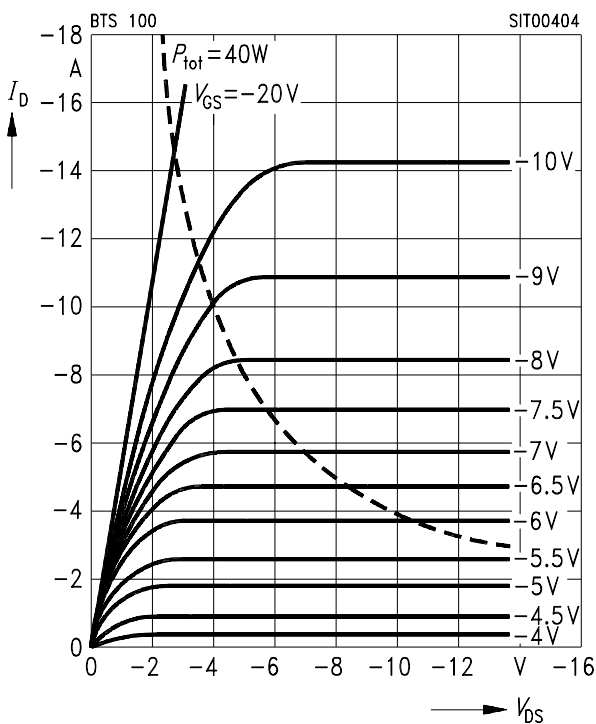

Safe operating area $I_D = f(V_{DS})$

Parameter: $D = 0.01, T_C = 25 \text{ °C}$

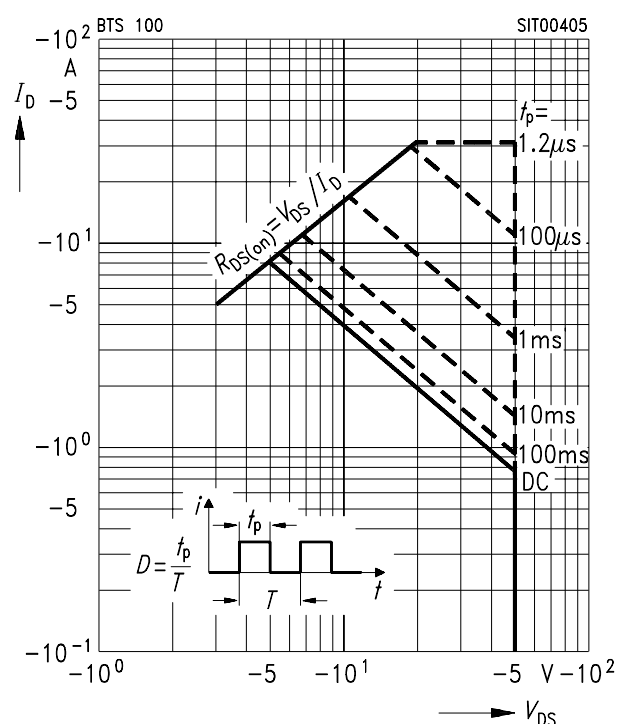

Drain-source on-state resistance

$R_{DS(on)} = f(T_j)$

Parameter: $I_D = -5\text{ A}$, $V_{GS} = -10\text{ V}$

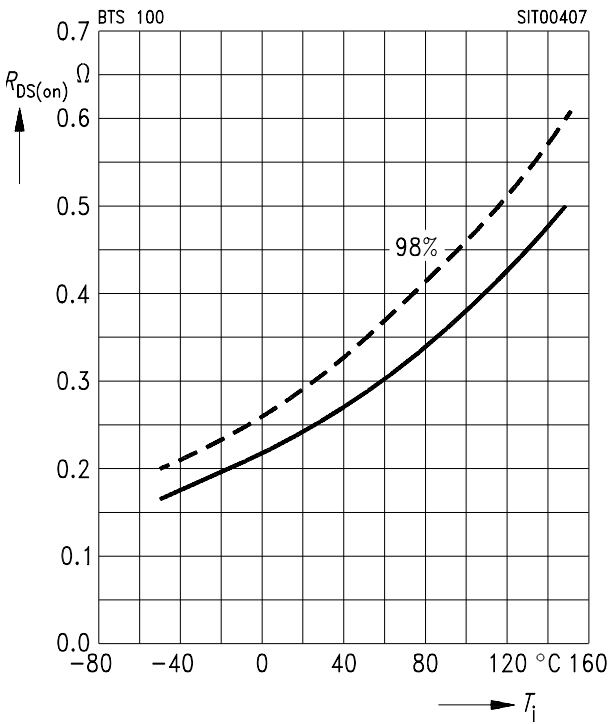

Gate threshold voltage $V_{GS(th)} = f(T_j)$

Parameter: $V_{DS} = V_{GS}$, $I_D = -1\text{ mA}$

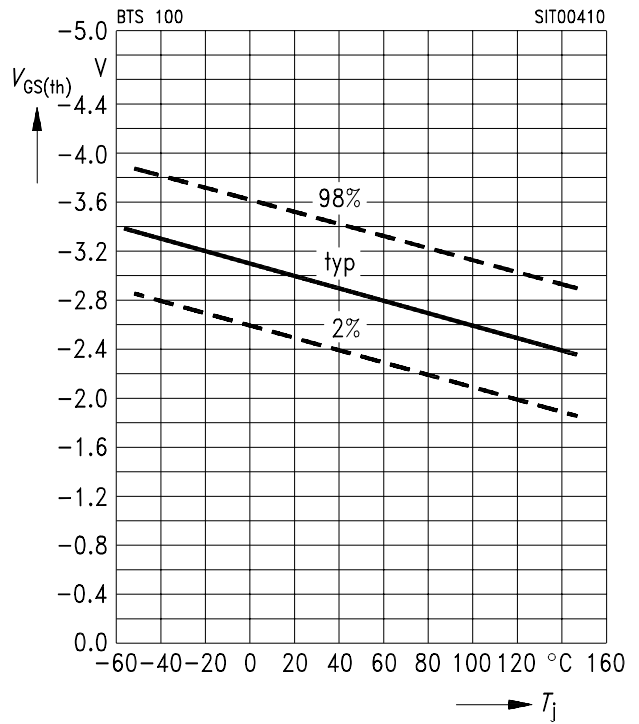

Typ. transfer characteristic

$I_D = f(V_{GS})$

Parameter: $t_p = 80\text{ }\mu\text{s}$, $V_{DS} = -25\text{ V}$

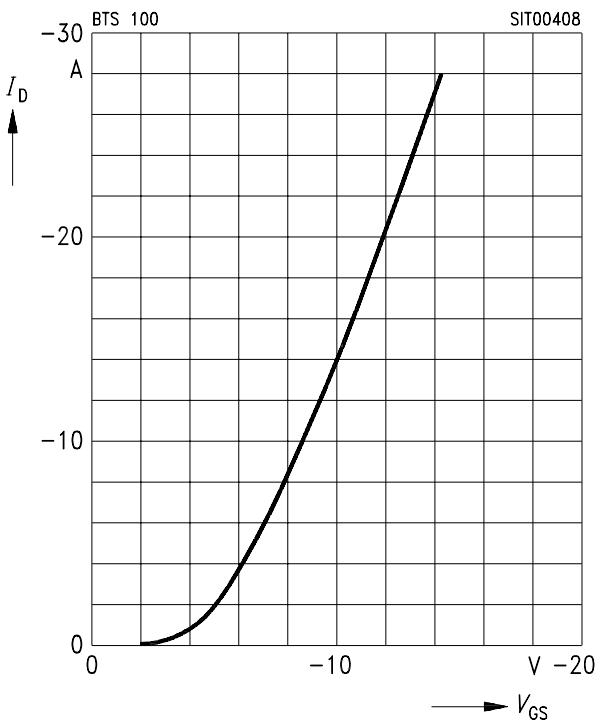

Typ. transconductance $g_{fs} = f(I_D)$

Parameter: $t_p = 80\text{ }\mu\text{s}$, $V_{DS} = -25\text{ V}$

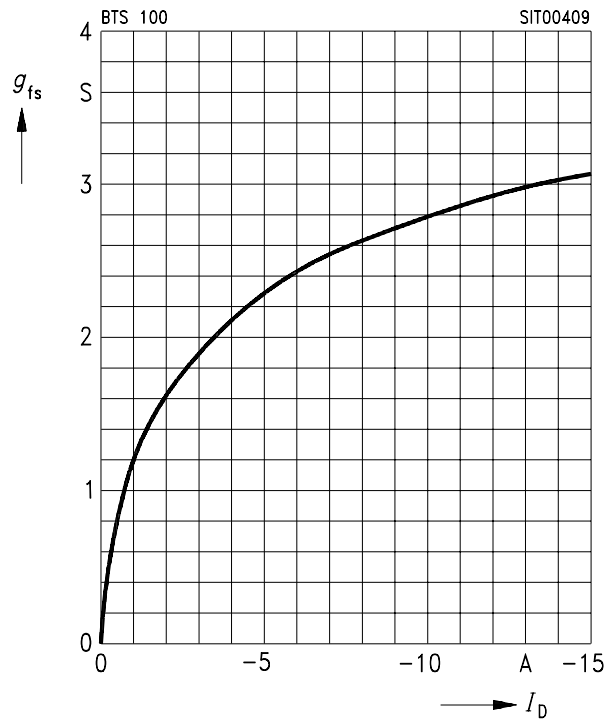

Continuous drain current $I_D = f(T_C)$

Parameter: $V_{GS} \geq -10 \text{ V}$

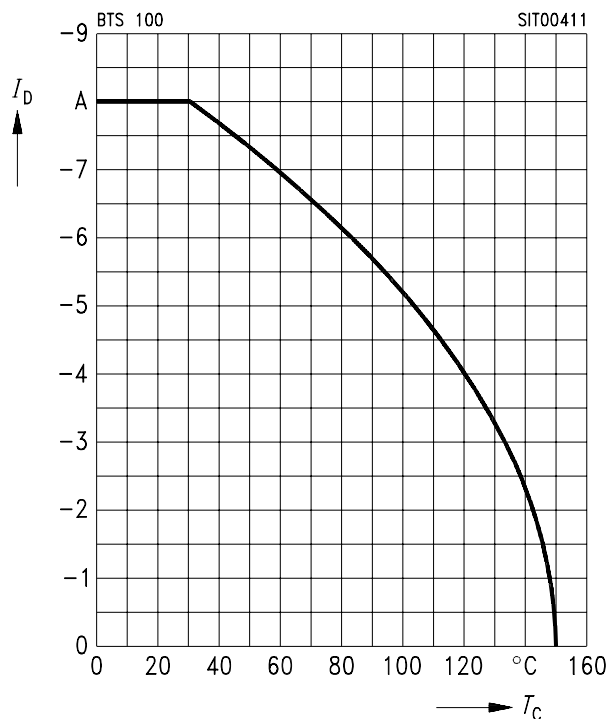

Forward characteristics of reverse diode $I_F = f(V_{SD})$

Parameter: $T_j, t_p = 80 \mu\text{s}$

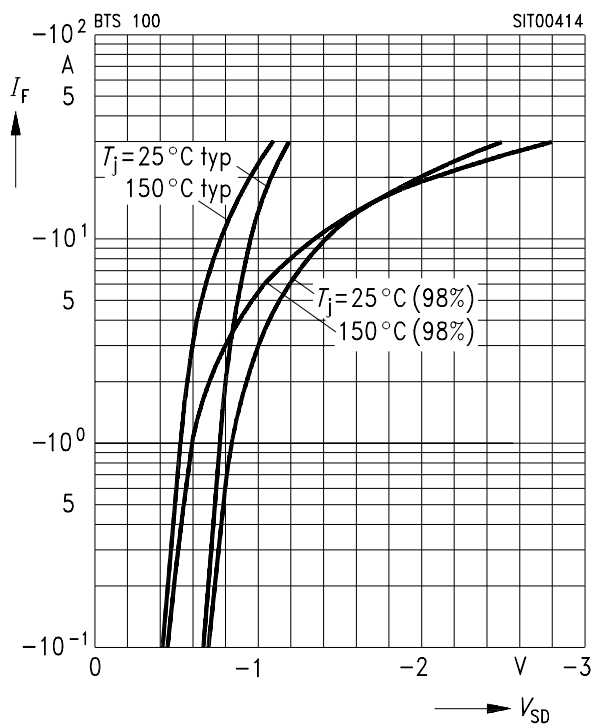

Typ. gate-source leakage current $I_{GSS} = f(T_C)$

Parameter: $V_{GS} = -20 \text{ V}, V_{DS} = 0$

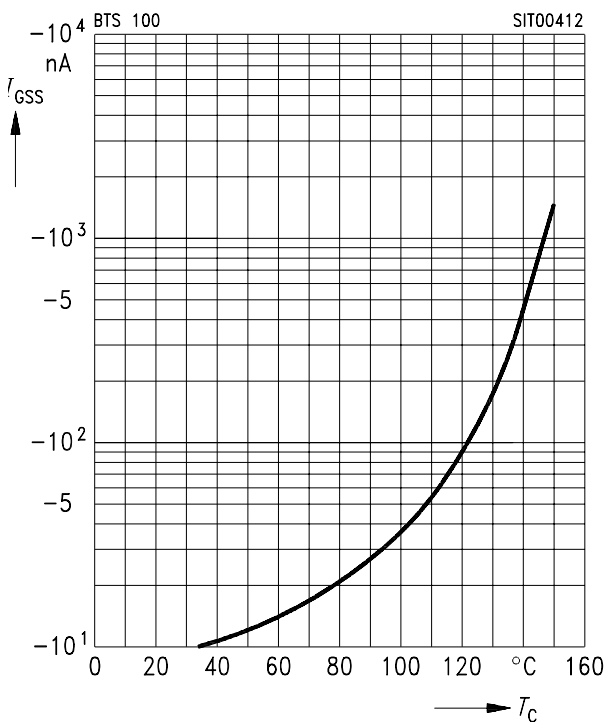

Typ. capacitances $C = f(V_{DS})$

Parameter: $V_{GS} = 0, f = 1 \text{ MHz}$

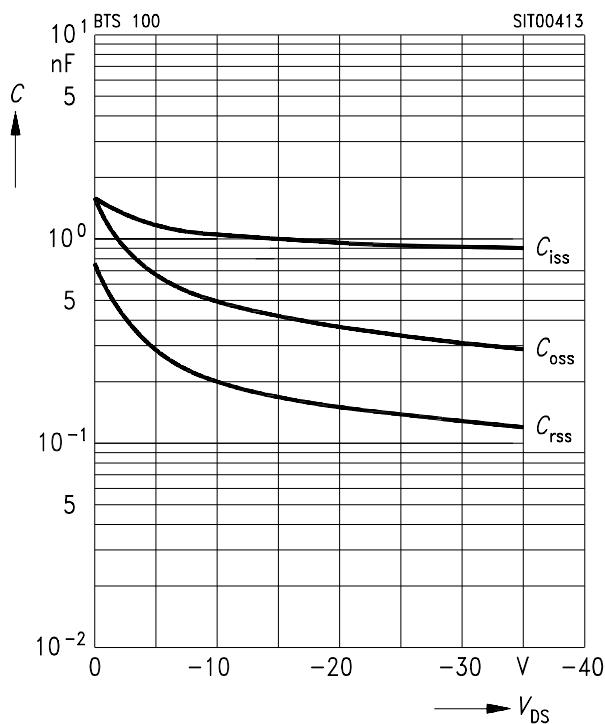

Transient thermal impedance $Z_{thJC} = f(t_p)$

Parameter: $D = t_p/T$

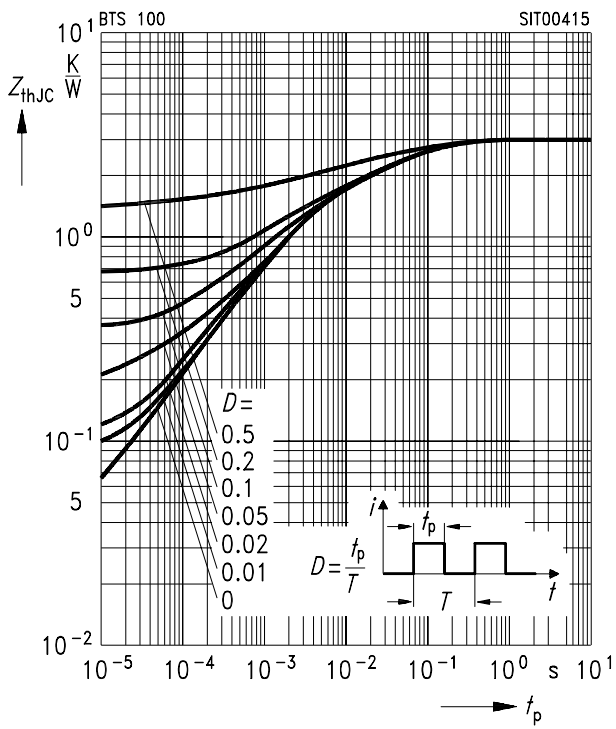

TO 220 AB
Standard

Ordering Code
C67078-A5007-A2

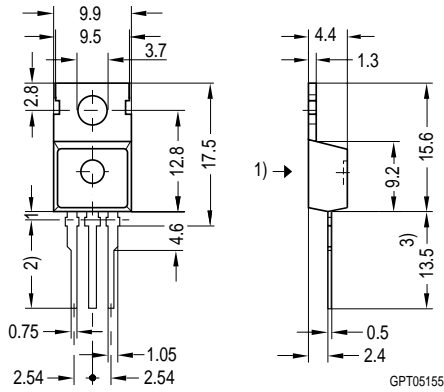

- 1) punch direction, burr max. 0.04
- 2) dip tinning
- 3) max. 14.5 by dip tinning press burr max. 0.05

TO 220 AB
SMD Version E3045
SMD T&R E3045A

Ordering Code
C67078-A5007-A7
C67078-A5007-A12

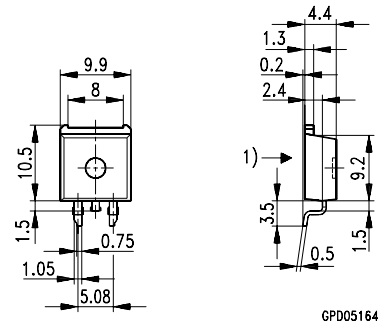

- 1) shear and punch direction no burrs this surface